



5840
PENTODE
 Five-Star Tube
 ★ ★ ★ ★ ★

FOR WIDE-BAND HIGH-FREQUENCY AMPLIFIER APPLICATIONS

8-LEAD SUBMINIATURE
SHARP-CUTOFF CHARACTERISTIC
HIGH TRANSCONDUCTANCE

SHOCK, VIBRATION RATINGS
HEATER-CYCLING RATING

DESCRIPTION AND RATING

The 5840 is a subminiature sharp-cutoff pentode for use in high-frequency circuits.

The 5840 is a special-quality tube for use in critical industrial and military applications where operational dependability is of primary importance. Features of the tube include a high degree of mechanical strength and a heater-cathode construction capable of withstanding many-thousand cycles of intermittent operation. When used in on-off control applications, the tube will maintain its emission capabilities after long periods of operation under cutoff conditions.

GENERAL

ELECTRICAL

Cathode—Coated Unipotential

Heater Voltage, AC or DC $6.3 \pm 5\%$ Volts

Heater Current 0.15 Amperes

Direct Interelectrode Capacitances

	With Shield*	Without Shield
Grid-Number 1 to Plate, maximum	0.015	0.03 $\mu\mu\text{f}$
Input	4.2	4.0 $\mu\mu\text{f}$
Output	3.4	1.9 $\mu\mu\text{f}$

*With external shield of 0.405-inch inside diameter connected to cathode.

MECHANICAL

Mounting Position—Any

Envelope—T-3, Glass

Base—E8-10, Subminiature Button 8-Lead

BASING DIAGRAM

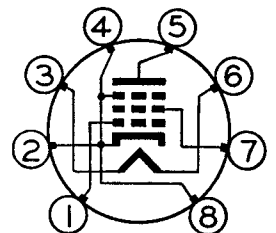

RETMA 8DL

TERMINAL CONNECTIONS

- Lead 1—Grid Number 1
- Lead 2—Cathode and Grid Number 3
- Lead 3—Heater
- Lead 4—Cathode and Grid Number 3
- Lead 5—Plate
- Lead 6—Heater
- Lead 7—Grid Number 2 (Screen)
- Lead 8—Cathode and Grid Number 3

PHYSICAL DIMENSIONS

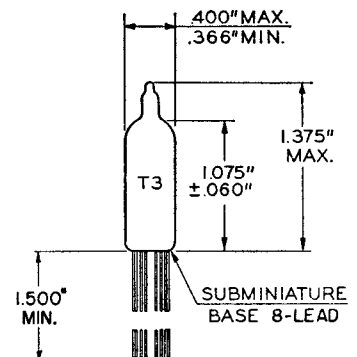

RETMA 3-1



MAXIMUM RATINGS

ABSOLUTE MAXIMUM VALUES

Plate Voltage	165 Volts
Screen Voltage	155 Volts
Negative DC Grid-Number 1 Voltage	55 Volts
Plate Dissipation	0.8 Watts
Screen Dissipation	0.35 Watts
DC Cathode Current	16.5 Milliamperes
Heater-Cathode Voltage	
Heater Positive with Respect to Cathode	200 Volts
Heater Negative with Respect to Cathode	200 Volts
Bulb Temperature at Hottest Point	220 C

CHARACTERISTICS AND TYPICAL OPERATION

CLASS A₁ AMPLIFIER

Plate Voltage	100 Volts
Screen Voltage	100 Volts
Cathode-Bias Resistor	150 Ohms
Plate Resistance, approximate	0.26 Megohms
Transconductance	5000 Micromhos
Plate Current	7.5 Milliamperes
Screen Current	2.4 Milliamperes
Grid-Number 1 Voltage, approximate	
I _b = 10 Microamperes	-9.0 Volts

CLASS A RESISTANCE-COUPLED AMPLIFIER

LOW IMPEDANCE DRIVE (APPROXIMATELY 200 OHMS)													
R _L	R _{gf}	E _{bb} = 90 Volts				E _{bb} = 150 Volts				E _{bb} = 225 Volts			
		R _k	R _{c2}	E _o	Gain	R _k	R _{c2}	E _o	Gain	R _k	R _{c2}	E _o	Gain
0.10	0.10	1000	0.2	13	50	500	0.3	19	83	400	0.3	29	110
0.10	0.24	1000	0.2	16	73	500	0.3	25	120	400	0.3	38	160
0.24	0.24	1700	0.5	13	72	1500	0.6	20	100	700	0.8	29	160
0.24	0.51	2000	0.6	15	89	1500	0.7	24	140	700	0.9	35	210
0.51	0.51	2500	1.3	11	93	2000	1.5	18	140	1000	1.7	28	200
0.51	1.0	3000	1.5	13	110	2000	1.7	20	180	1000	2.0	31	260

Notes:

1. E_o is maximum RMS voltage output for approximately five percent total harmonic distortion.
2. Gain is measured for an output voltage of two volts RMS
3. R_k is in ohms; R_{c2}, R_L, and R_{gf} are in megohms.
4. Coupling capacitors (C) should be selected to give desired frequency response. R_k and R_{c2} should be adequately by-passed.

HIGH IMPEDANCE DRIVE (APPROXIMATELY 100K OHMS)													
R _L	R _{gf}	E _{bb} = 90 Volts				E _{bb} = 150 Volts				E _{bb} = 225 Volts			
		R _k	R _{c2}	E _o	Gain	R _k	R _{c2}	E _o	Gain	R _k	R _{c2}	E _o	Gain
0.10	0.10	1200	0.2	13	48	700	0.2	18	77	500	0.3	28	110
0.10	0.24	1300	0.2	16	70	800	0.3	24	110	500	0.3	37	150
0.24	0.24	2800	0.4	12	68	1700	0.6	20	100	1200	0.8	29	150
0.24	0.51	3000	0.5	15	82	1800	0.7	24	140	1300	0.8	35	190
0.51	0.51	5500	1.0	11	76	3500	1.3	18	120	2400	1.6	26	180
0.51	1.0	6200	1.2	12	92	3800	1.6	19	160	2500	1.8	31	230

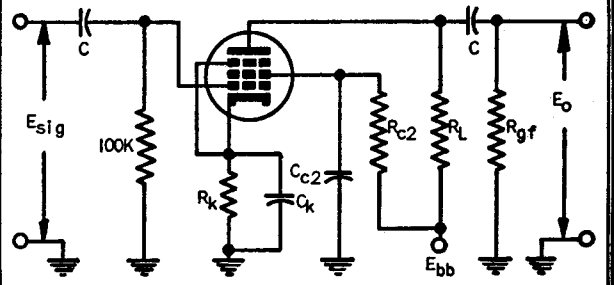

CHARACTERISTICS LIMITS

	Minimum	Maximum	
Heater Current			
Ef = 6.3 volts.....Initial	140	160	Milliamperes
500-Hr	138	164	Milliamperes
Plate Current			
Ef = 6.3 volts, Eb = 100 volts, Ec2 = 100 volts, Rk = 150 ohms (by-passed) ..Initial	5.5	9.5	Milliamperes
Screen Current			
Ef = 6.3 volts, Eb = 100 volts, Ec2 = 100 volts, Rk = 150 ohms (by-passed) ..Initial	1.5	3.3	Milliamperes
Transconductance (1)			
Ef = 6.3 volts, Eb = 100 volts, Ec2 = 100 volts, Rk = 150 Ohms (by-passed) .Initial	4200	5800	Micromhos
Transconductance Change with Heater Voltage			
Difference between Transconductance (1) and Transconductance at Ef = 5.7 volts (other conditions the same) expressed as a percentage of Transconductance (1).....Initial	10	Percent
500-Hr	15	Percent
Transconductance Change with Operation			
Difference between Transconductance (1) initially and after operation expressed as a percentage of initial value.....500-Hr	20	Percent
Average Transconductance Change with Operation			
Average of values for "Transconductance Change with Operation".....500-Hr	15	Percent
Plate Resistance			
Ef = 6.3 volts, Eb = 100 volts, Ec2 = 100 volts, Rk = 150 ohms (by-passed) ..Initial	0.175	Megohms
Plate Current Cutoff			
Ef = 6.3 volts, Eb = 100 volts, Ec2 = 100 volts, Ec1 = -9.0 volts.....Initial	50	Microamperes
Interelectrode Capacitances			
Grid-Number 1 to Plate (g1 to p).....Initial	0.015	$\mu\mu\text{f}$
Input (g1 to h, k, g2, g3).....Initial	3.5	4.9	$\mu\mu\text{f}$
Output (p to h, k, g2, g3).....Initial	2.9	3.9	$\mu\mu\text{f}$
Measured with external shield of 0.405-inch inside diameter connected to cathode.			
Negative Grid-Number 1 Current			
Ef = 6.3 volts, Eb = 100 volts, Ec2 = 100 volts, Rk = 150 ohms (by-passed), Rg1 = 1.0 meg.....Initial	0.3	Microamperes
500-Hr	0.8	Microamperes
Heater-Cathode Leakage Current			
Ef = 6.3 volts, Ehk = 100 volts,			
Heater Positive with Respect to Cathode.....Initial	5.0	Microamperes
500-Hr	10	Microamperes
Heater Negative with Respect to Cathode.....Initial	5.0	Microamperes
500-Hr	10	Microamperes
Interelectrode Leakage Resistance			
Ef = 6.3 volts. Polarity of applied d-c interelectrode voltage is such that no cathode emission results			
Grid-Number 1 to All at 100 Volts DC.....Initial	100	Megohms
500-Hr	50	Megohms
Plate to All at 300 Volts DC.....Initial	100	Megohms
500-Hr	50	Megohms
Vibrational Noise Output Voltage RMS			
Ef = 6.3 volts, Ebb = 100 volts, Ec2 = 100 volts, Rk = 150 ohms (by-passed), R _L = 10,000 ohms, Vibrational acceleration = 15 G at 40 cps.....Initial	60	Millivolts
Grid-Number 1 Emission Current			
Ef = 7.5 volts, Eb = 100 volts, Ec2 = 100 volts, Ecc1 = -9.0 volts, Rg1 = 1.0 meg.....Initial	0.5	Microamperes

The indicated 500-hour values are life-test end points for the following conditions of operation: Ef = 6.3 volts, Eb = 100 volts, Ec2 = 100 volts, Rk = 150 ohms, Rg1 = 1.0 meg, Ehk = 200 volts with heater positive with respect to cathode, and bulb temperature = 220 C minimum.

SPECIAL TESTS AND RATINGS

Stability Life Test

Statistical sample operated for one hour to evaluate and control initial variations in transconductance.

Survival Rate Life Test

Statistical sample operated for one hundred hours to evaluate and control early-life electrical and mechanical in-operatives.

Heater-Cycling Life Test

Statistical sample operated for 2000 cycles to evaluate and control heater-cathode defects. Conditions of test include $E_f = 7.0$ volts cycled for one minute on and four minutes off, $E_b = E_{c2} = E_{c1} = 0$ volts, and $E_{hk} = 140$ volts RMS.

Shock Rating—450 G

Statistical sample subjected to five impact accelerations of 450 G in each of four different positions. The accelerating forces are applied by the Navy-type, High Impact (flyweight) Shock Machine for Electronic Devices or its equivalent.

Fatigue Rating—2.5 G

Statistical sample subjected to vibrational acceleration of 2.5 G for 32 hours minimum in each of three different positions. The sinusoidal vibration is applied at a fixed frequency between 25 and 60 cycles per second.

Altitude Rating—60,000 Feet

Statistical sample subjected to pressure of 55 millimeters of mercury to evaluate and control arcing and corona.

Note: The conditions for some of the indicated tests have deliberately been selected to aggravate tube failures for test and evaluation purposes. In no sense should these conditions be interpreted as suitable circuit operating conditions. In the design of military equipment employing this tube, reference should be made to the appropriate MIL-E-1 specification.

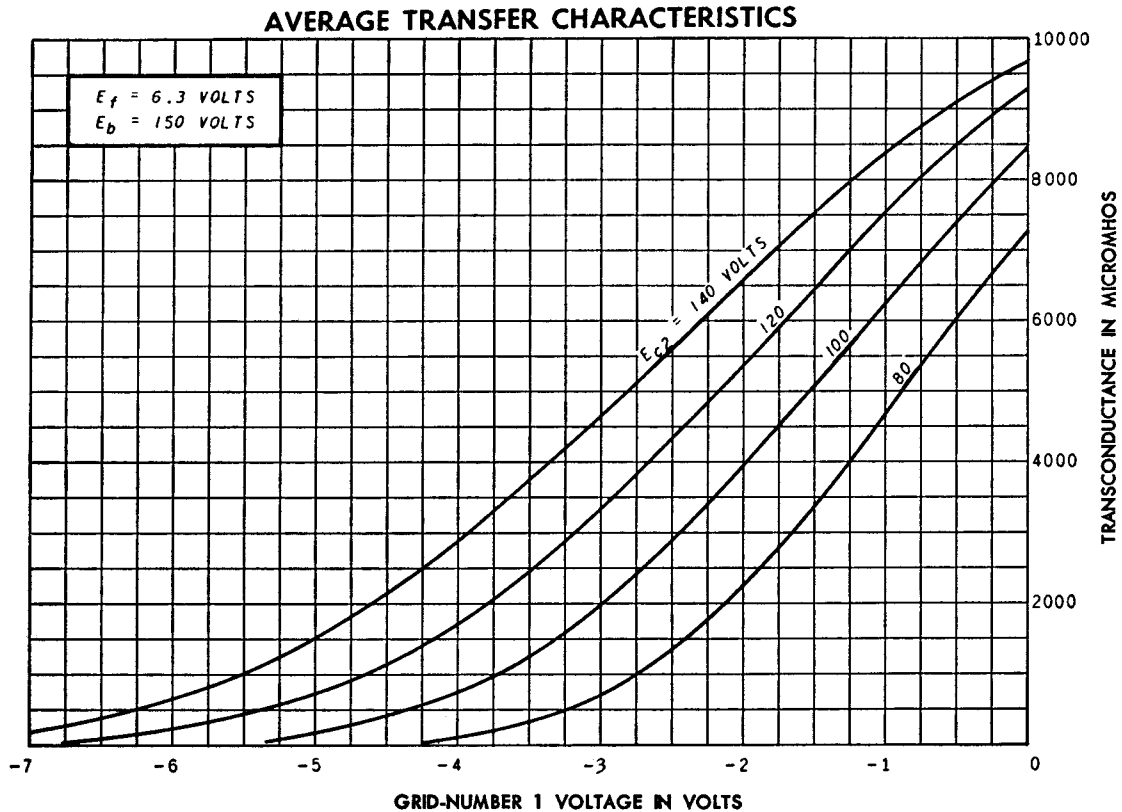

AVERAGE PLATE CHARACTERISTICS

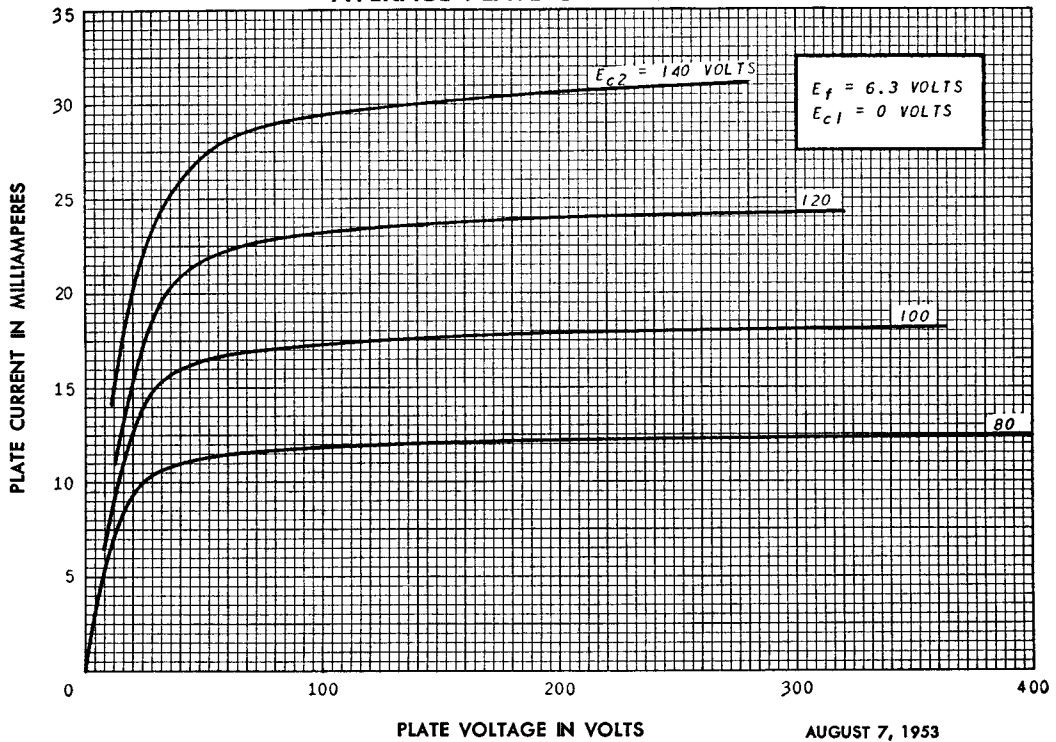

AVERAGE PLATE CHARACTERISTICS

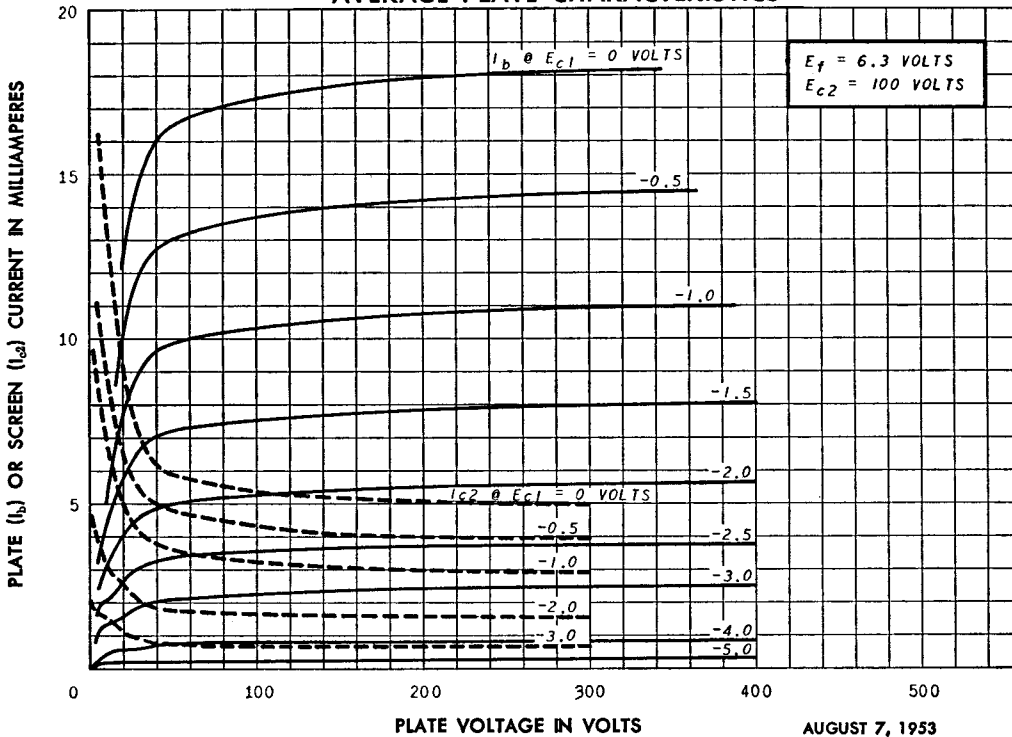

AVERAGE TRANSFER CHARACTERISTICS

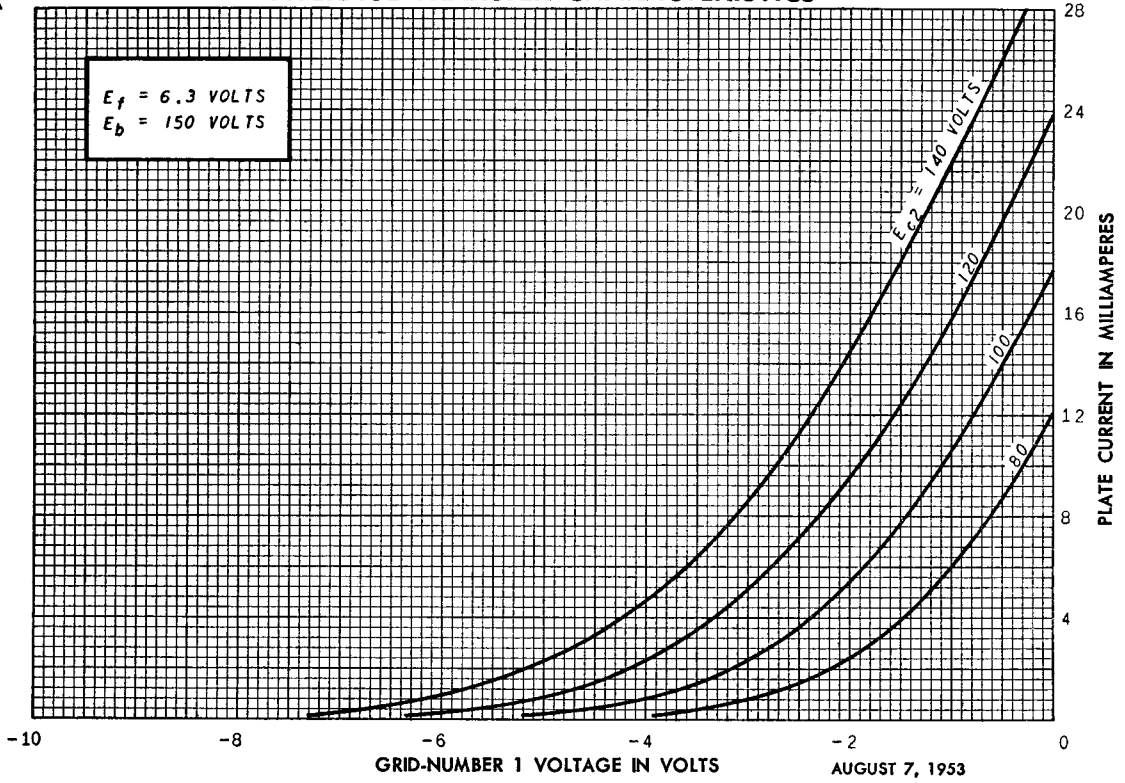

AVERAGE TRANSFER CHARACTERISTICS

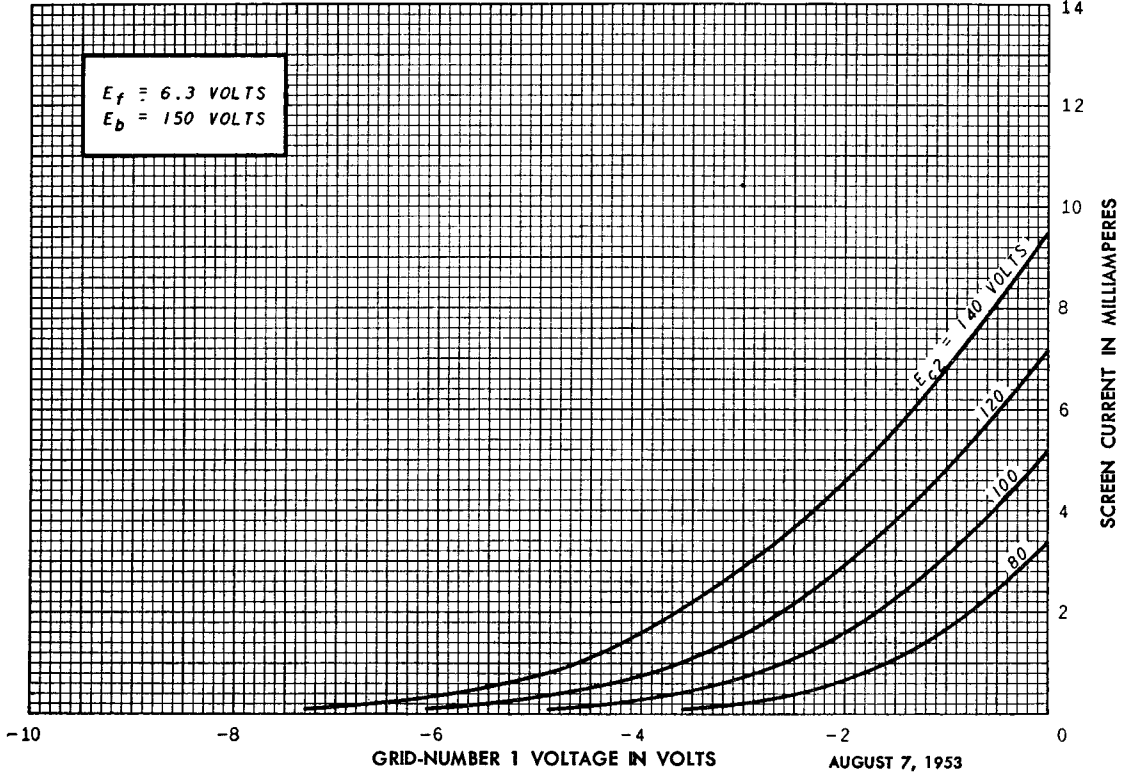

ELECTRONIC COMPONENTS DIVISION



Schenectady 5, N. Y.